

Spherical plain bearing

GOHR-K...DO-GIHR-K60DO

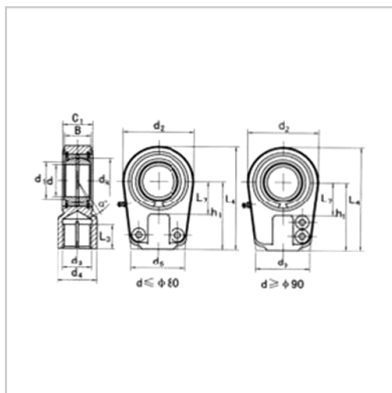

model :	GIHR-K60DO
---------	------------

Size mm :

d :	60
d3 6H :	M58 × 1.5
D :	75
L ø :	59
B :	44
C1 :	50
d2 :	130
L7 min :	65
h1 :	130
L4 :	200
d5 :	120
d1 :	66.8
dk :	80
:	6

Load KN :

move :	245
quiet :	400
Weight kg :	5.4

: