

Spherical plain bearing

SA...E(S),SA...ES 2RS-**SA40ES**

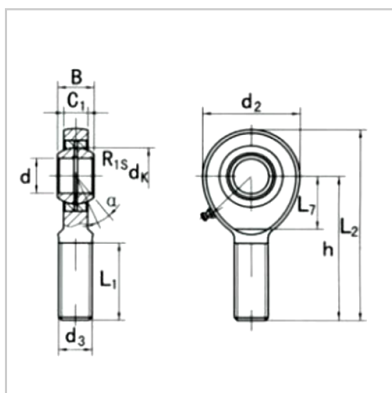

model :	SA40ES
---------	--------

Size mm :

d :	40
d3 6g :	M39x3.0
B :	28
C1 :	23
L min :	86
D :	92
L min :	48
h :	150
L :	196
dk :	53
R1S :	0.6
:	7

Load KN :

Dynamic C :	100
Static G0 :	180
Weight kg :	1.8

: