

Fully loaded roller bearing

Excavator bearing-AC4629



Bearing model : AC4629

Overall dimension (mm) :

d :	230
D :	290
B :	27

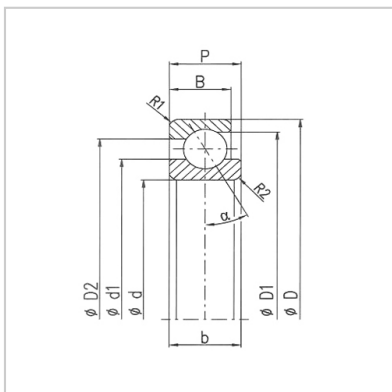

: